

Product Type: Plug-in terminal-Plug

Product Name:MC-

RHH10.16H03C-K-0001

Product Description: Pitch:10.16mm Rated Voltage : 1000V Rated Current:76A Connection method : Screw connection colour : customizable

Product Size

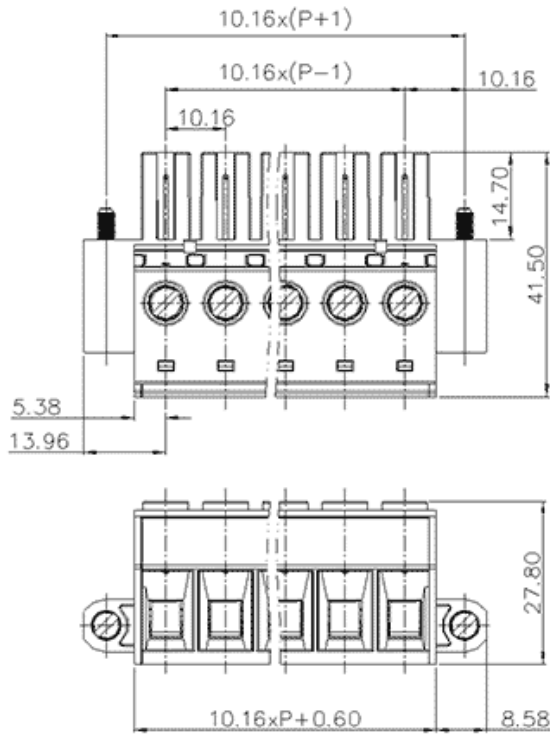

Parameters

⌘ SUPU ID	MC-RHH10.16H03C-K-0001
⌘ Pitch	10.16
⌘ Number of levels	single layer
⌘ Number of connections	3

☞ Connection method	Screw connection
☞ Protection Level	IP20
☞ Operating temperature range	-40~+105°C
☞ Insulation material	PA66
☞ Insulation material group	I
☞ Contact material	Copper alloy
☞ Contact plating	Sn,Plated
☞ Color	Green/Black/Blue/Grey/Orange/Red

Technical data

☞ IEC Rated Current	76A
☞ IEC Rated Voltage	1000V
☞ Overvoltage category	III/III/ II
☞ Degree of pollution	3 2 2
☞ Rated impulse voltage	8.0KV 8.0KV8.0KV
☞ UL Rated Current	55A 55A -
☞ UL Rated Voltage	600V 600V -
☞ Conductor cross section rigid	0.5-16mm ²
☞ Conductor cross section flexible	0.5-16mm ²
☞ Conductor cross section flexible,with furrule	0.5-16mm ²
☞ Locking screw Specification	M4
☞ Locking screw torque	1.2N.m
☞ Fixed Screw Specification	M3
☞ 固定螺钉扭矩	0.5N.m

☞ Stripping length	12mm
☞ Use group	B/C/D
☞ Rated cross section	20~6AWG

Commercial data

☞ Order No	MC-RHH10.16H03C-K-0001
------------	------------------------

Ningbo SUPU Electronics Co., Ltd.

Address: No. 150, Xinxing 4th Road, High-tech Industrial Development Zone,
Cixi City, Zhejiang Province, China

Zip code: 315303

Switchboard: +86 574-63288158

Fax: +86 574-63288170

E-mail:supucontact@supu.cn

Service Hotline: 400-626-6336



Wechat