

Product Type: Plug-in terminal-Socket

Product Name:MC-PF3.5H14P-FB-0001

Product Description: Pitch: 3.5mm Rated Voltage : 160V Rated Current: 8A Connection method : Push in Connection colour : customizable

Product Size

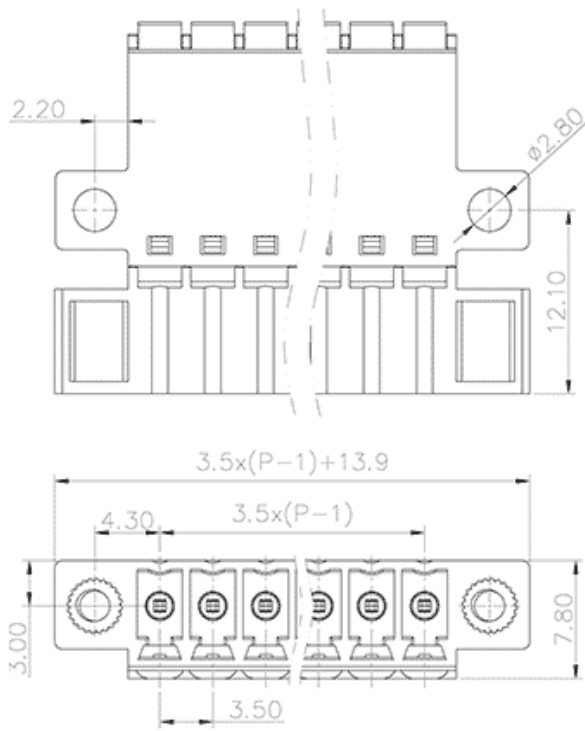

Parameters

| | |
|-------------------------|----------------------|
| ⌘ SUPU ID | MC-PF3.5H14P-FB-0001 |
| ⌘ Pitch | 3.5 |
| ⌘ Number of levels | Single layer |
| ⌘ Number of connections | 14 |

| | |
|-------------------------------|----------------------------------|
| ☞ Connection method | Push in connection |
| ☞ Protection Level | IP20 |
| ☞ Operating temperature range | -40~+105°C |
| ☞ Insulation material | PA66 |
| ☞ Insulation material group | I |
| ☞ Contact material | Copper alloy |
| ☞ Contact plating | Sn,Plated |
| ☞ Color | Green/Black/Blue/Grey/Orange/Red |

Technical data

| | |
|---|------------------------|
| ☞ IEC Rated Current | 160V |
| ☞ IEC Rated Voltage | 8A |
| ☞ Overvoltage category | III III II |
| ☞ Degree of pollution | 3 2 2 |
| ☞ Rated impulse voltage | 2.5KV 2.5KV 2.5KV |
| ☞ UL Rated Current | 8A 8A 8A |
| ☞ UL Rated Voltage | 150V 50V 150V |
| ☞ Conductor cross section rigid | 0.2-1.5mm ² |
| ☞ Conductor cross section flexible | 0.2-1.5mm ² |
| ☞ Conductor cross section flexible,with ferrule | 0.2-1.5mm ² |
| ☞ Stripping length | 10mm |
| ☞ Use group | B/C/D |
| ☞ Rated cross section | 24-16AWG |

Commercial data

Ningbo SUPU Electronics Co., Ltd.

Address: No. 150, Xinxing 4th Road, High-tech Industrial Development Zone,
Cixi City, Zhejiang Province, China

Zip code: 315303

Switchboard: +86 574-63288158

Fax: +86 574-63288170

E-mail:supucontact@supu.cn

Service Hotline: 400-626-6336



Wechat