

Product Type: IP67 connector

Product Name:ESF-RS120A25BC

Product Description: Connectors suitable for energy storage modules: Color: Black Wire cross-section: 25mm² Rated voltage: 1500V DC Rated current: 120A Connection method: crimping Contact type: Pin

Product Size

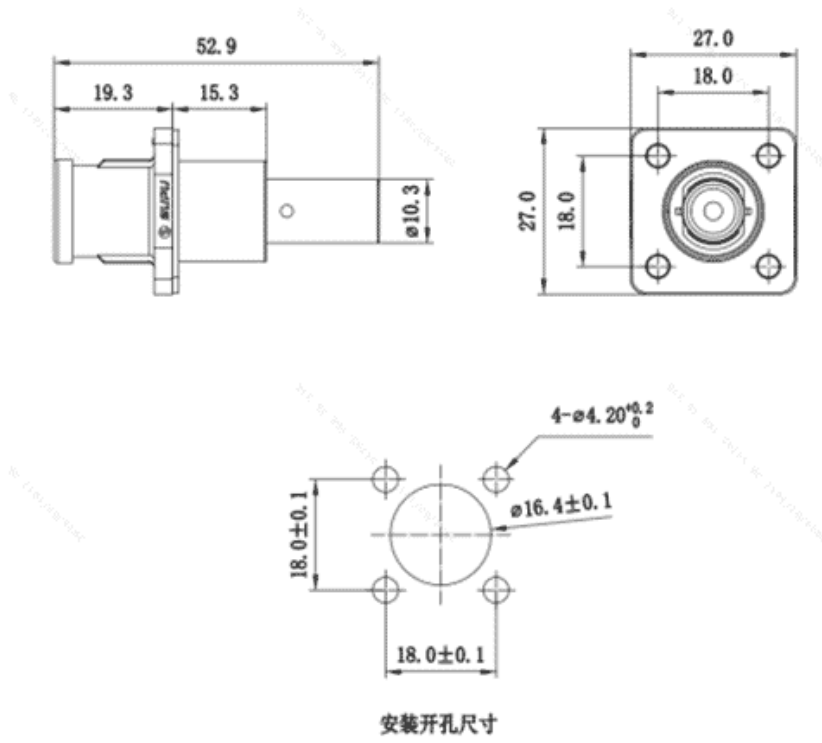

Parameters

SUPU ID	ESF-RS120A25BC
Number of connections	1
Connection method	压接

☞ Protection Level	IP67
☞ Operating temperature range	-40°C~125°C
☞ Insulation material	PA
☞ Insulation material group	III
☞ Contact material	Copper alloy
☞ Contact plating	Ag,Plated
☞ Insertion/withdrawal cycles	100
☞ Insertion force	≤75N
☞ Withdrawal force	≥10N

Technical data

☞ Overvoltage category	III
☞ Degree of pollution	3
☞ Rated impulse voltage	12.3KV
☞ UL Rated Current	120A
☞ UL Rated Voltage	1500V
☞ Stripping length	20mm±1mm
☞ Rated cross section	25mm ² (AWG4)
☞ Rated cross section(AWG)	25mm ² (AWG4)
☞ External cable diameter	/

Commercial data

☞ Order No	ESF-RS120A25BC
☞ Packing unit	1

☞ Minimum order quantity

PCS

☞ Single piece weight

23.3g

Ningbo SUPU Electronics Co., Ltd.

Address: No. 150, Xinxing 4th Road, High-tech Industrial Development Zone,
Cixi City, Zhejiang Province, China

Zip code: 315303

Switchboard: +86 574-63288158

Fax: +86 574-63288170

E-mail:supucontact@supu.cn

Service Hotline: 400-626-6336



Wechat

Date:2026-06-13 11:02

The right to modify data belongs to SUPU.