

Product Type: M8 Moulded Connector

Product Name: M8A04Z-FMSST-UP001B



Product Description: M8A moulded straight female 4-core unshielded PUR wire 1 m

Product Size

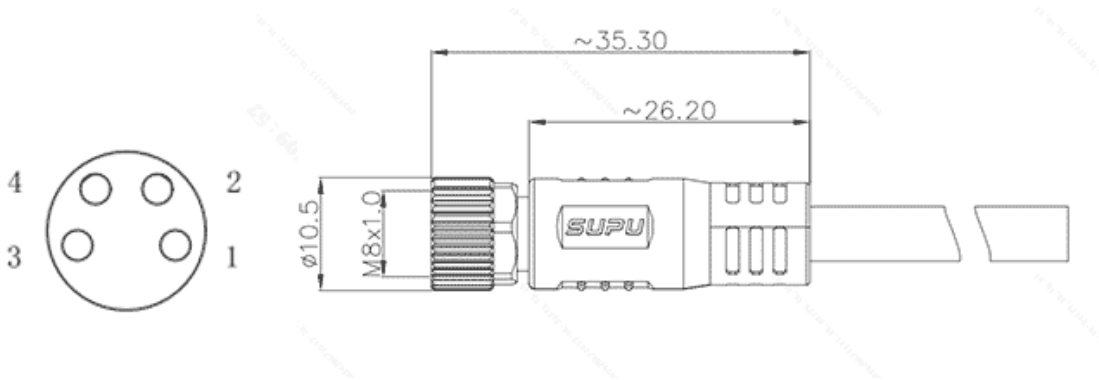

Parameters

☞ SUPU ID	M8
☞ Number of connections	4
☞ Protection Level	IP67
☞ Operating temperature range	-40~+85

☞ Thread type	M8X1.0
☞ Category	孔式
☞ Product type	预铸成型式
☞ Coding	A
☞ Connection method	预铸成型式
☞ Shielded	NO
☞ Mechanical endurance	≥100
☞ Standards	IEC61076-2-104

Commercial data

☞ Order No	M8A04Z-FMSST-UP001B
☞ Packing unit	PCS
☞ Minimum order quantity	1

Ningbo SUPU Electronics Co., Ltd.

Address: No. 150, Xinxing 4th Road, High-tech Industrial Development Zone,

Cixi City, Zhejiang Province, China

Zip code: 315303

Switchboard: +86 574-63288158

Fax: +86 574-63288170

E-mail:supucontact@supu.cn

Service Hotline: 400-626-6336



Wechat

Date:2026-05-09 12:02

The right to modify data belongs to SUPU.