



Product Type: Heavy-duty Connector Housing

Product Name: S48B-SM-1L.M-2PG36-PC

Product Description: S48B Housings, metal, 1 levers, surface mounting, 2xPG36 thread, plastic cover

Product Size

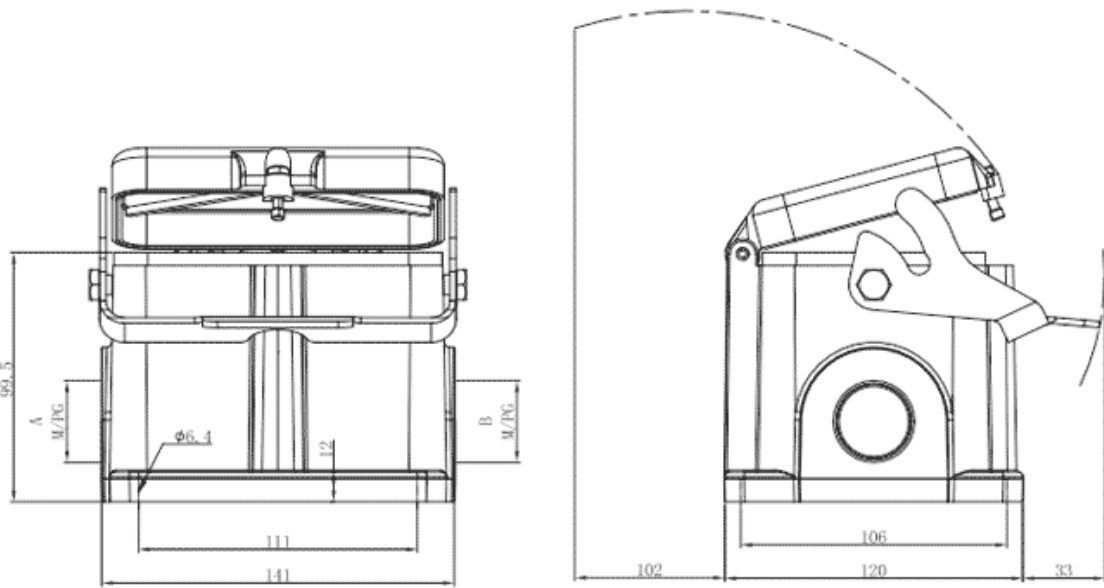

Parameters

<p>☞ SUPU ID</p>	S48B-SM-1L.M-2PG36-PC
<p>☞ Protection Level</p>	IP65
<p>☞ Operating temperature range</p>	-40°C~+125°C
<p>☞ Color</p>	Grey

☞ Thread type	PG36
☞ Category	Base
☞ Mechanical endurance	≥500

## Technical data

☞ Sealing material	NBR
☞ Housing Material	Die-Cast Aluminum

## Commercial data

☞ Order No	S48B-SM-1L.M-2PG36-PC
☞ Packing unit	PCS
☞ Minimum order quantity	1

### Ningbo SUPU Electronics Co., Ltd.

Address: No. 150, Xinxing 4th Road, High-tech Industrial Development Zone,

Cixi City, Zhejiang Province, China

Zip code: 315303

Switchboard: +86 574-63288158

Fax: +86 574-63288170

E-mail: [supucontact@supu.cn](mailto:supucontact@supu.cn)

Service Hotline: 400-626-6336



Wechat

---

Date:2026-05-25 21:33

The right to modify data belongs to SUPU.