



Product Type: Heavy-duty Connector Housing

Product Name:S32B-SM-1L.M-M32-MC

Product Description: S32B Housings,metal,1 levers,surface mounting,M32 thread,metal cover

Product Size

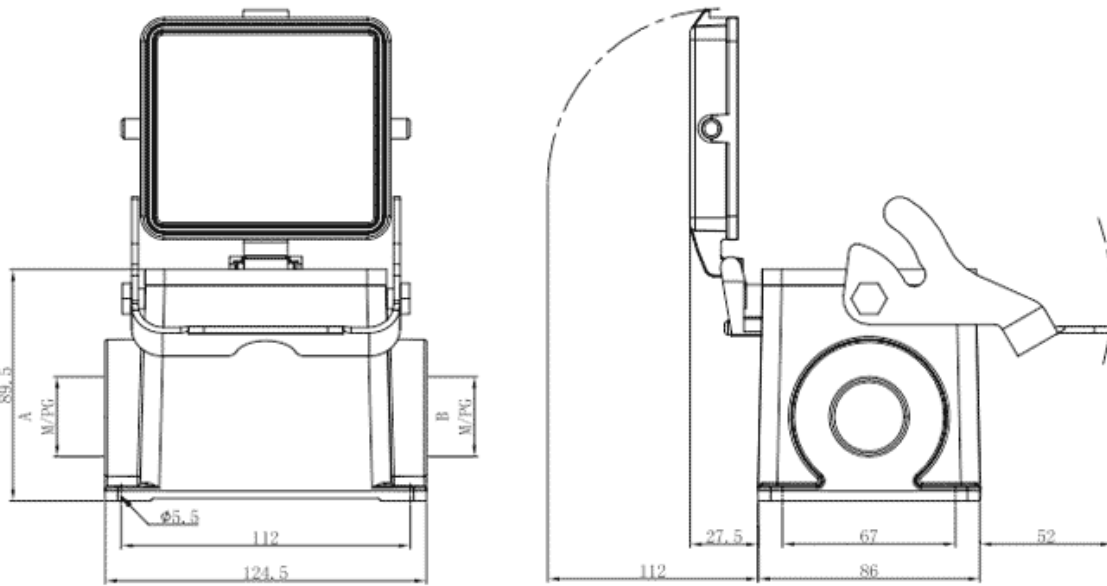

Parameters

<p>☞ SUPU ID</p>	S32B-SM-1L.M-M32-MC
<p>☞ Protection Level</p>	IP65
<p>☞ Operating temperature range</p>	-40°C~+125°C
<p>☞ Color</p>	Grey

☞ Thread type	M32
☞ Category	Base
☞ Mechanical endurance	≥500

Technical data

☞ Sealing material	NBR
☞ Housing Material	Die-Cast Aluminum

Commercial data

☞ Order No	S32B-SM-1L.M-M32-MC
☞ Packing unit	PCS
☞ Minimum order quantity	1

Ningbo SUPU Electronics Co., Ltd.

Address: No. 150, Xinxing 4th Road, High-tech Industrial Development Zone,

Cixi City, Zhejiang Province, China

Zip code: 315303

Switchboard: +86 574-63288158

Fax: +86 574-63288170

E-mail: supucontact@supu.cn

Service Hotline: 400-626-6336



Wechat

Date:2026-05-02 07:59

The right to modify data belongs to SUPU.