



Product Type: Heavy-duty Connector Housing

Product Name:S10B-SM-1L.M-M25

Product Description: S10B Housings,metal,1 levers,surface mounting,M25 thread

Product Size

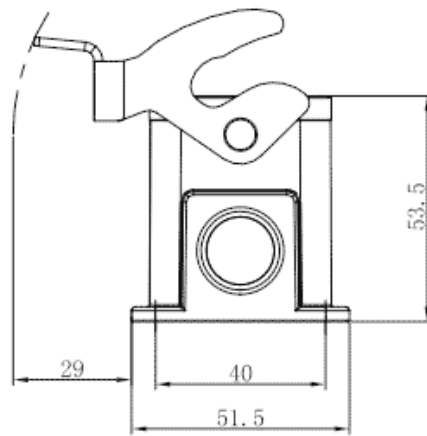
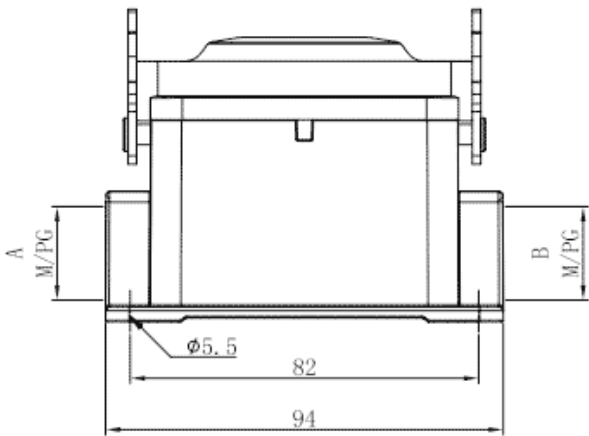

Parameters

| | |
|-------------------------------|------------------|
| ☞ SUPU ID | S10B-SM-1L.M-M25 |
| ☞ Protection Level | IP65 |
| ☞ Operating temperature range | -40°C~+125°C |
| ☞ Color | Grey |

| | |
|------------------------|------|
| ☞ Thread type | M25 |
| ☞ Category | Base |
| ☞ Mechanical endurance | ≥500 |

Technical data

| | |
|--------------------|-------------------|
| ☞ Sealing material | NBR |
| ☞ Housing Material | Die-Cast Aluminum |

Commercial data

| | |
|--------------------------|------------------|
| ☞ Order No | S10B-SM-1L.M-M25 |
| ☞ Packing unit | PCS |
| ☞ Minimum order quantity | 1 |

Ningbo SUPU Electronics Co., Ltd.

Address: No. 150, Xinxing 4th Road, High-tech Industrial Development Zone,

Cixi City, Zhejiang Province, China

Zip code: 315303

Switchboard: +86 574-63288158

Fax: +86 574-63288170

E-mail: supucontact@supu.cn

Service Hotline: 400-626-6336



Wechat

Date:2026-05-02 10:52

The right to modify data belongs to SUPU.