

Product Type: Heavy-duty Connector Housing

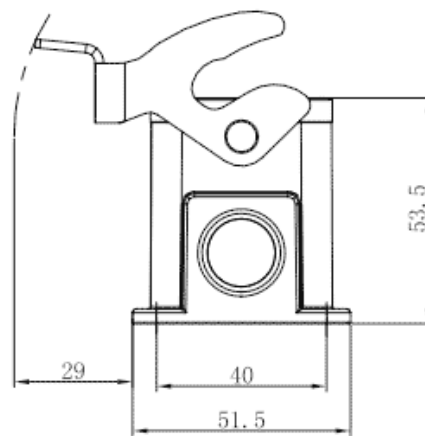

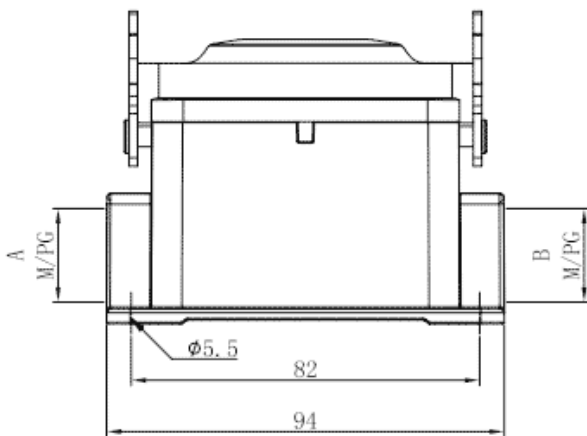

Product Name: S10B-SM-1L.M-2M20

Product Description: S10B Housings, metal, 1 levers, surface mounting, 2xM20 thread

Product Size



Parameters

 SUPU ID	S10B-SM-1L.M-2M20
 Protection Level	IP65
 Operating temperature range	-40°C~+125°C
 Color	Grey

☞ Thread type	M20
☞ Category	Base
☞ Mechanical endurance	≥500

Technical data

☞ Sealing material	NBR
☞ Housing Material	Die-Cast Aluminum

Commercial data

☞ Order No	S10B-SM-1L.M-2M20
☞ Packing unit	PCS
☞ Minimum order quantity	1

Ningbo SUPU Electronics Co., Ltd.

Address: No. 150, Xinxing 4th Road, High-tech Industrial Development Zone,

Cixi City, Zhejiang Province, China

Zip code: 315303

Switchboard: +86 574-63288158

Fax: +86 574-63288170

E-mail: supucontact@supu.cn

Service Hotline: 400-626-6336



Wechat

Date:2025-07-25 10:52

The right to modify data belongs to SUPU.