

Product Type: Heavy-duty Connector Housing

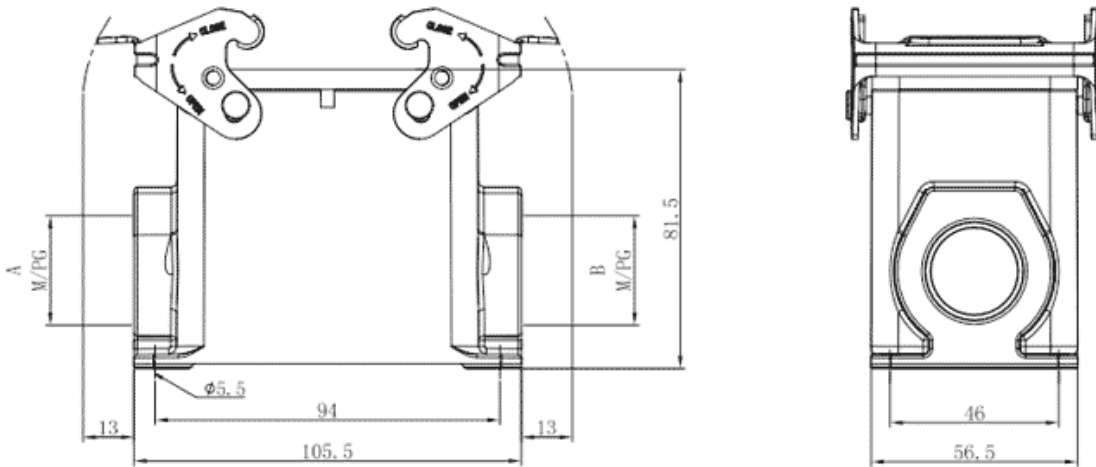



Product Name: S32A-SM-2L.M-2PG29

Product Description: S32A Housings, metal, 2 levers, surface mounting, 2xPG29 thread

Product Size



Parameters

<p> SUPU ID</p>	S32A-SM-2L.M-2PG29
<p> Protection Level</p>	IP65
<p> Operating temperature range</p>	-40°C~+125°C
<p> Color</p>	Grey

☞ Thread type	PG29
☞ Category	Base
☞ Mechanical endurance	≥500

Technical data

☞ Sealing material	NBR
☞ Housing Material	Die-Cast Aluminum

Commercial data

☞ Order No	S32A-SM-2L.M-2PG29
☞ Packing unit	PCS
☞ Minimum order quantity	1

Ningbo SUPU Electronics Co., Ltd.

Address: No. 150, Xinxing 4th Road, High-tech Industrial Development Zone,

Cixi City, Zhejiang Province, China

Zip code: 315303

Switchboard: +86 574-63288158

Fax: +86 574-63288170

E-mail: supucontact@supu.cn

Service Hotline: 400-626-6336



Wechat

Date:2026-05-25 21:26

The right to modify data belongs to SUPU.