

Product Type: Spring-cage terminal

## Product Name:204951

Product Description: Connection method:Spring-cage connection,IEC Rated Current:32A,IEC Rated Voltage:800V,Number of connections:3,Number of levels : 1,Cross section:28-12AWG

### Product Size

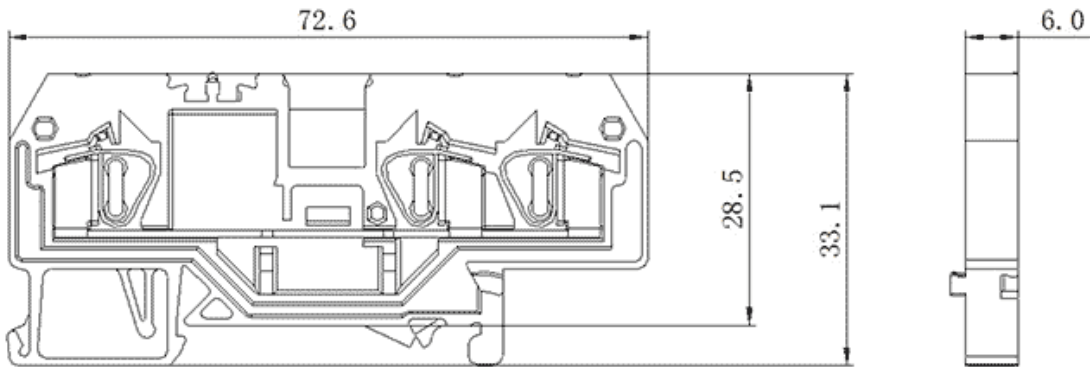

### Parameters

☞ SUPU ID	204951
☞ Width	6mm
☞ Number of levels	1
☞ Number of connections	3

☞ Connection method	Spring-cage connection
☞ Protection Level	IP20
☞ Insulation material	PA66
☞ Insulation material group	I
☞ Contact material	Copper alloy
☞ Contact plating	Sn,Plated
☞ Ambient temperature (operation)	-40°C~105°C
☞ Ambient temperature (assembly)	-5°C~70°C
☞ Ambient temperature (storage)	-25°C~60°C
☞ Permissible humidity (storage/transport)	30%~70%

## Commercial data

☞ Order No	204951
------------	--------

### Ningbo SUPU Electronics Co., Ltd.

Address: No. 150, Xinxing 4th Road, High-tech Industrial Development Zone,

Cixi City, Zhejiang Province, China

Zip code: 315303

Switchboard: +86 574-63288158

Fax: +86 574-63288170

E-mail:supucontact@supu.cn

Service Hotline: 400-626-6336



Wechat

---

Date:2026-05-13 15:49

The right to modify data belongs to SUPU.